

SLW

SCHWEGMAN ■ LUNDBERG ■ WOESSNER
Intellectual Property Attorneys

PATENT PROTECTION FOR HIGH TECHNOLOGY

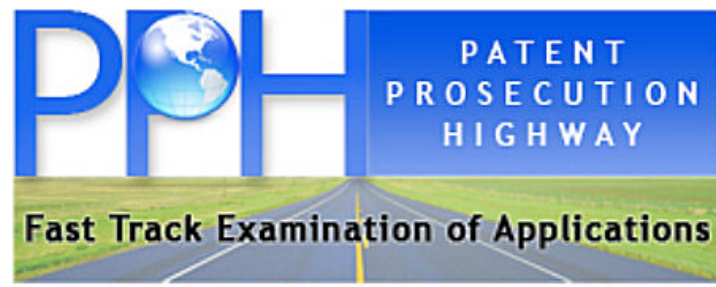

Suneel Arora
612 373 6951
sarora@slwip.com



James D. Hallenbeck
612 373 6938
jhallenbeck@slwip.com

MINNESOTA

1600 TCF Tower
121 South 8th Street
Minneapolis, MN 55402
612.373.6900

CALIFORNIA

150 Almaden Boulevard
Suite 750
San Jose, CA 95113
408.278.4040

TEXAS

8911 Capital of Texas Highway
Suite 4150
Austin, TX 78759
512.628.9320

Patent Prosecution Highway – Agenda

- Define The PPH
- Where The PPH Can Be Used
- When And How To Use The PPH
- Experience Statistics
- Why And Why Not To Use The PPH
- Example Strategies

Patent Prosecution Highway – Agenda

- **Define The PPH**
- Where The PPH Can Be Used
- When And How To Use The PPH
- Experience Statistics
- Why And Why Not To Use The PPH
- Example Strategies

Patent Prosecution Highway – Defined

- PPH leverages fast-track examination procedures already available in a patent Office of Second Filing (OSF)/Office of Later Examination (OLE) to allow applicants in the OSF/OLE to obtain patents corresponding to those in a patent Office of First Filing (OFF)/Office of Earlier Examination (OEE) faster and more efficiently.
 - The PPH is defined in a series of bilateral agreements.
(see http://www.uspto.gov/patents/init_events/pph/index.jsp)
-
- **OFF – Office of First Filing**
 - **OSF – Office of Second Filing**
 - **OEE - – Office of Earlier Examination**
 - **OLE – Office of Later Examination**

Patent Prosecution Highway – Agenda

- Define The PPH
- **Where The PPH Can Be Used**
- When And How To Use The PPH
- Experience Statistics
- Why And Why Not To Use The PPH
- Example Strategies

Patent Prosecution Highway – Bilateral Agreements in Place

PPH Programs With USPTO

Australia

Austria

Canada

Denmark

European Patent Office

Finland

Germany

Hungary

Israel

Japan

Korea

Mexico

Russia

Singapore

Spain

Taiwan

United Kingdom

As of September 23, 2011

Patent Prosecution Highway – Bilateral Agreements in Place

PCT-PPH Programs With USPTO

Australia

Austria

European Patent Office

Finland

Japan

Korea

Nordic Patent Institute

Russia

Spain

Sweden

As of September 23, 2011

Patent Prosecution Highway – PPH Mottainai

- PPH Mottainai embraces the notion that an allowance should not go to waste.
- Through PPH Mottainai, an allowance obtained in an OEE can be used to obtain PPH treatment in another PPH Mottainai participating office.
- The PPH Mottainai participating offices are:
 - Australia
 - Canada
 - Finland
 - Japan
 - Russia
 - Spain
 - The United Kingdom
 - The United States

As of September 23, 2011

Patent Prosecution Highway - Illustration

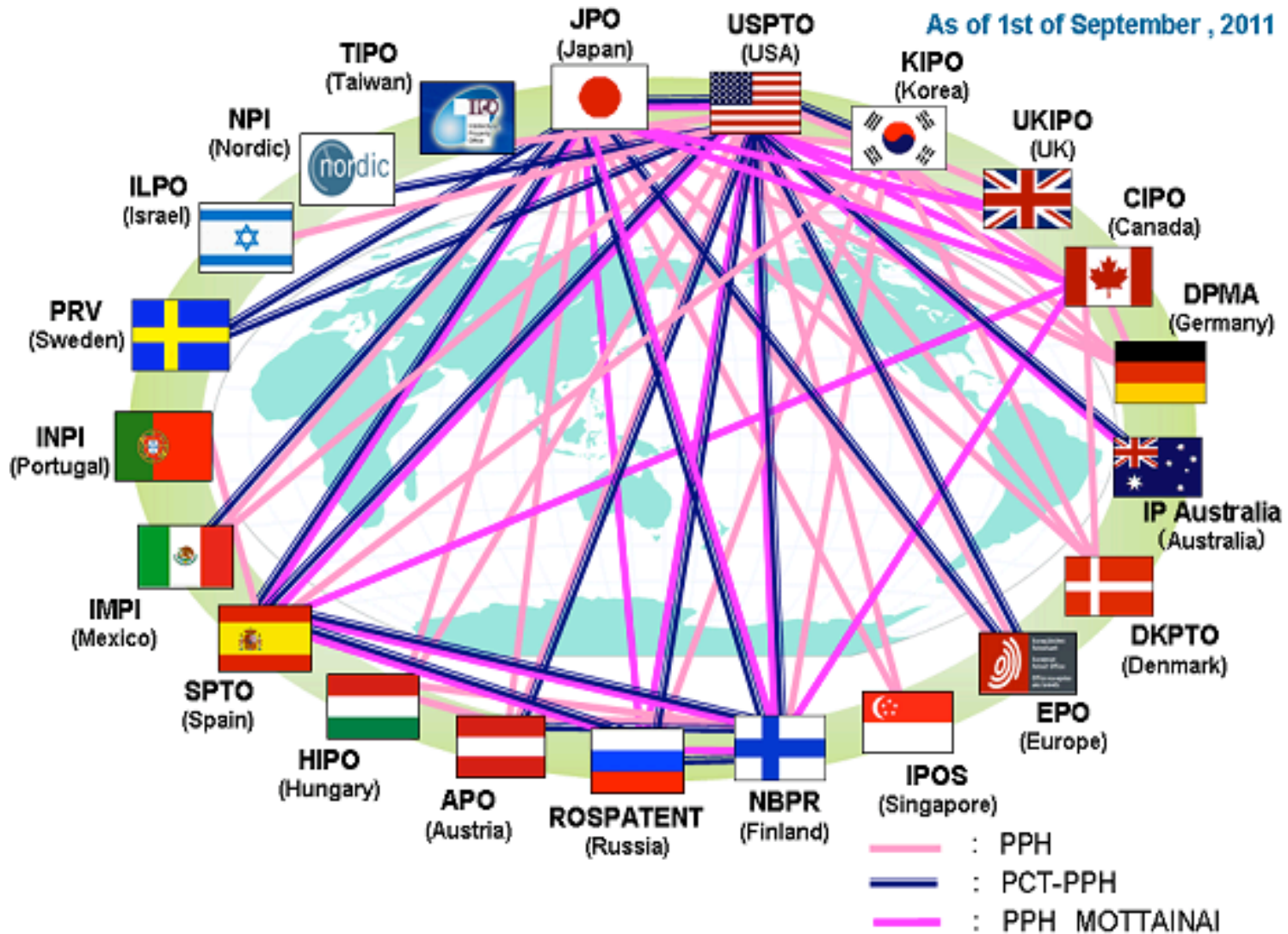

Courtesy of JPO

Patent Prosecution Highway – Agenda

- Define The PPH
- Where The PPH Can Be Used
- **When And How To Use The PPH**
- Experience Statistics
- Why And Why Not To Use The PPH
- Example Strategies

Patent Prosecution Highway – When it can be used

When examination has not commenced in an OSF/OSE:

- An applicant receiving an allowability determination from a participating OFF/OEE may request accelerated examination of sufficiently corresponding claims in another participating OSF/OLE.
 - The corresponding application(s) need not have been filed yet.
- Where a PCT search or examination report is prepared by a participating PCT-PPH office (e.g., USPTO, JPO, EPO, KPO) indicating allowability of at least one claim, PPH treatment may be requested with regard to national stage applications in PCT-PPH participating offices.
- In the US, if priority is not direct, but does intersect with an allowed application, it may still be possible to request PPH treatment.

Patent Prosecution Highway – “Sufficiently Correspond”

- Some or all of the claims in the PPH target (OSF/OLE) office must “sufficiently correspond” to the allowed claims in the OFF/OEE.
- Can be tricky, especially between the JPO and USPTO.
- Can make changes to claims to comport with OSF/OLE practice.
- Can add dependent claims, so long as they are supported by the application as filed.
- However, cannot add claims in a different category than the allowed claims.
- Generally, if you are pursuing narrower coverage than allowed in the OFF/OEE, the narrower limitations must be presented in dependent form first.
- If independent claim is then rejected, the narrowing limitation(s) from the dependent claim can then be incorporated into the independent claim.
- During prosecution, narrowing amendments are added through dependent claims.

Patent Prosecution Highway – Example Illustrations

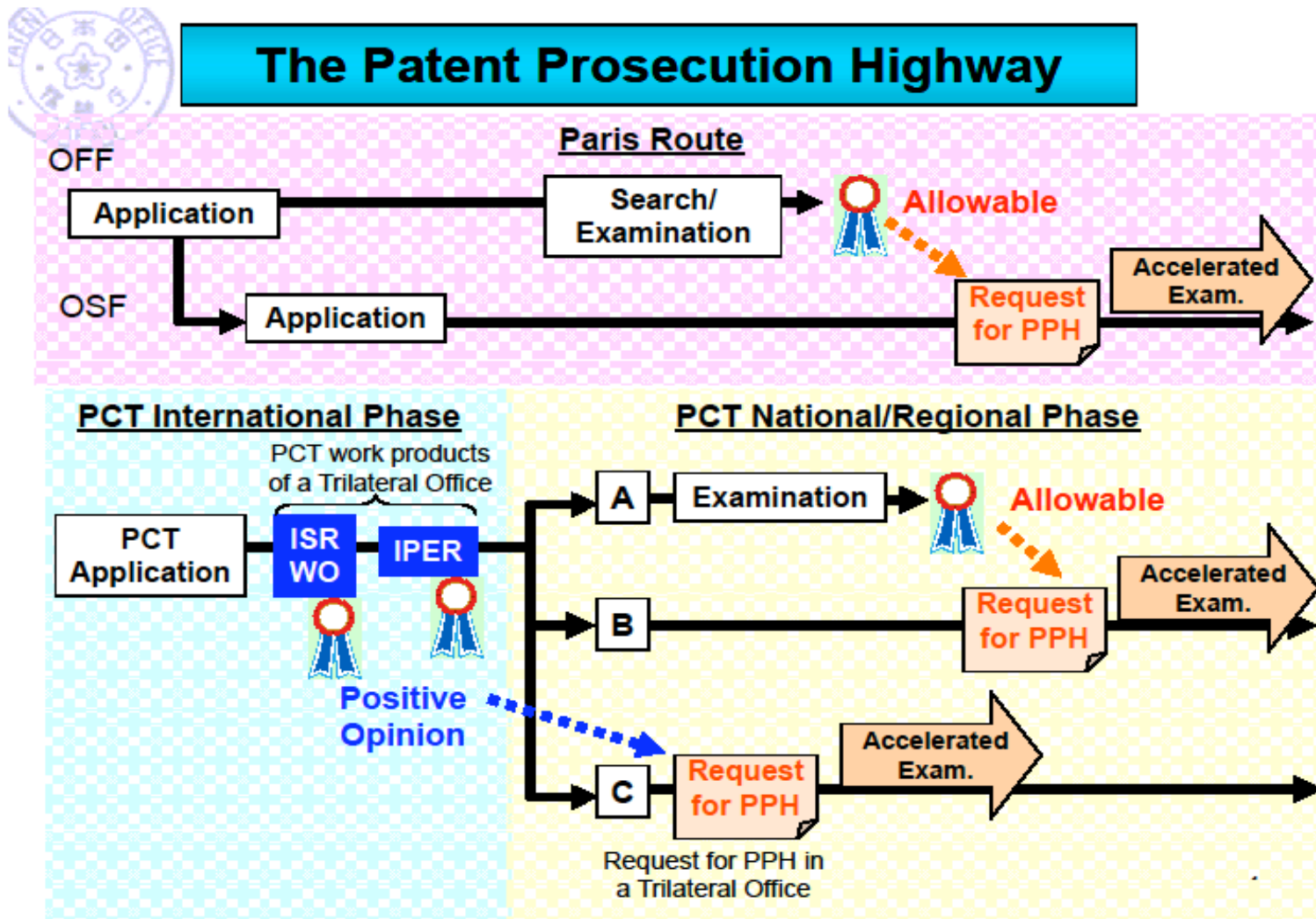

Courtesy of JPO - <http://www.jpo.go.jp/cgi/linke.cgi?url=/ppph-portal/index.htm>

Patent Prosecution Highway – Monttainai Example Illustrations

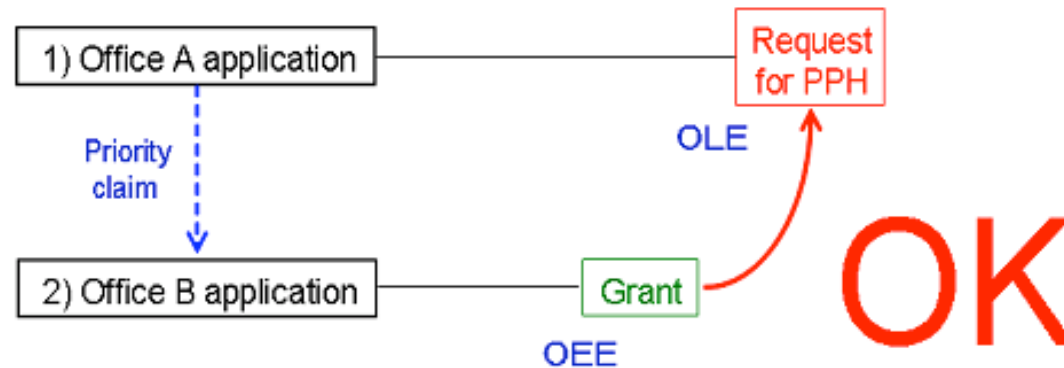

Case 1: OSF (Office B) provides the examination result to the OFF (Office A).

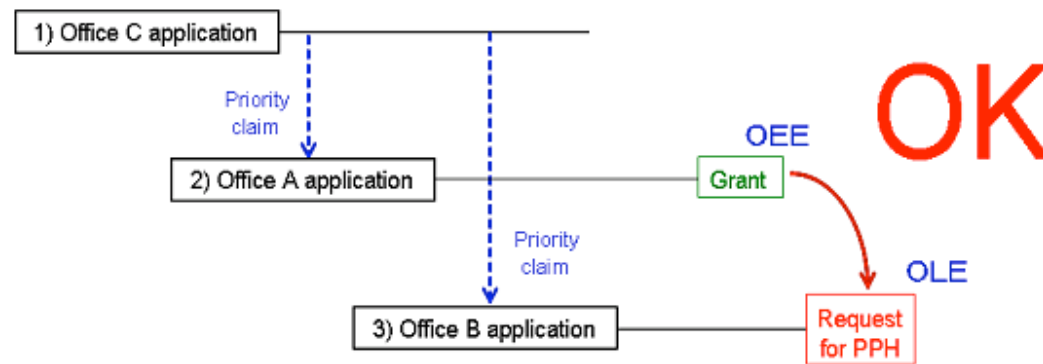

Case 2: OFF is other than Office A or Office B.

Courtesy of JPO - <http://www.jpo.go.jp/cgi/linke.cgi?url=/ppph-portal/index.htm>

Patent Prosecution Highway – Eligibility

- OFF/OEE must have a PPH agreement in place with the OSF/OLE
 - OSF/OEE application claims priority from OFF/OLE application or the priority claims between the OFF/OEE and OSF/OLE application intersect (e.g., common priority claims to a PCT application, a national application, or other PCT or Paris Convention priority claim)
 - OFF/OEE application has at least one allowed claim
 - All claims in OSF/OLE application correspond (may be amended to correspond) to allowed claims in OFF/OEE application
 - OSF/OLE application not yet examined (note: this could be a newly filed continuation or divisional application)
-
- **OFF – Office of First Filing**
 - **OSF – Office of Second Filing**
 - **OEE - – Office of Earlier Examination**
 - **OLE – Office of Later Examination**

Patent Prosecution Highway – Around the Horn

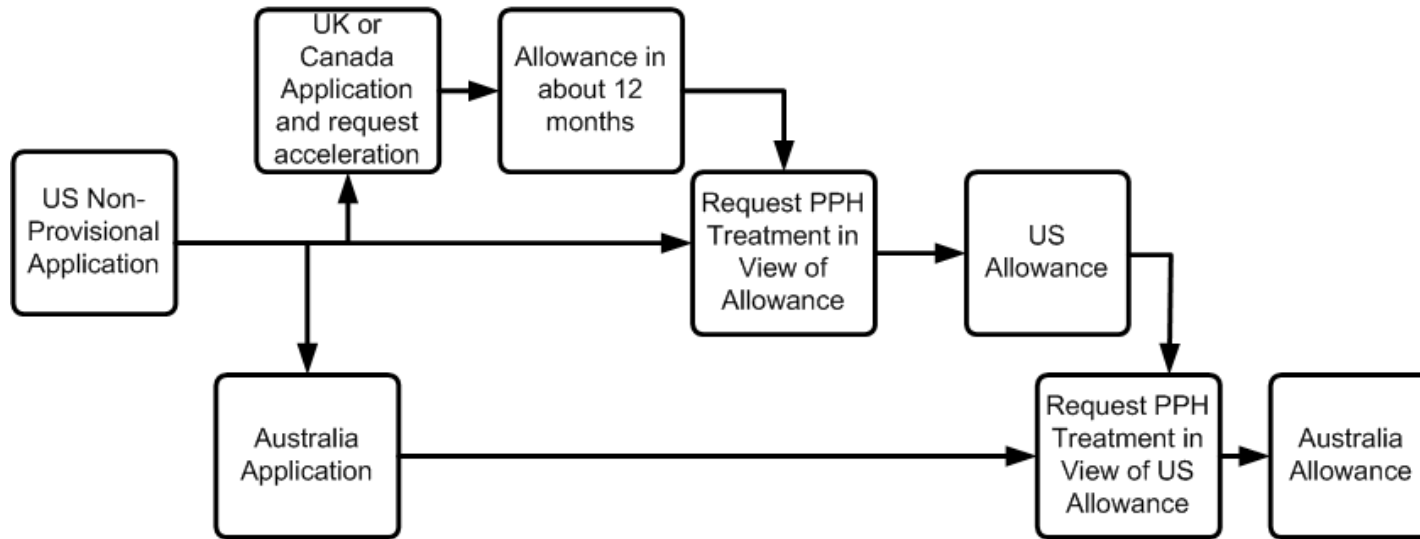

- The US has PPH-Monttarnai agreements with the UK, Canada, and Australia. However, the UK, Canada, and Australia do not have PPH-Monttarnai agreements with one another.
- By following the map of PPH agreements, it is possible to indirectly invoke PPH treatment in another country where there is no PPH agreement in place.
- The same idea applies to standard PPH, but you need to keep in mind and may need to adjust your filing strategy to account for the Office of First Filing.
 - For example, substitute Mexico for Australia and the above scenario would still work. (Mexico is standard PPH with the US and has no agreements with Canada or the UK).

No petition fee!



As of May 25, 2010

Patent Prosecution Highway – Agenda

- Define The PPH
- Where The PPH Can Be Used
- When And How To Use The PPH
- **Experience Statistics**
- Why And Why Not To Use The PPH
- Example Strategies

Patent Prosecution Highway – Number of National PPH Requests













Office of Second Filing

Office of First Filing	Office of Second Filing															
	JP	US	KR	GB	CA	DE	AU	DK	EP	SG	FI	RU	AT	HU	ES	Total
JP		3119	627	19	33	312	-	1	173	2	1	19	0	0	0	4306
US	1014		293	20	1325	9	64	0	94	2	1	0	0	0	0	2822
KR	113	593		1	3	0	-	0	-	-	0	0	-	-	-	710
GB	24	125	3		-	-	-	-	-	-	-	-	-	-	-	152
CA	0	47	0	-		0	-	0	-	-	0	-	-	-	0	47
DE	60	35	2	-	0		-	-	-	-	-	-	-	-	-	97
AU	-	56	-	-	-	-		-	-	-	-	-	-	-	-	56
DK	3	64	0	-	0	-	-		-	-	-	-	-	-	-	67
EP	16	87	-	-	-	-	-	-		-	-	-	-	-	-	103
SG	0	1	-	-	-	-	-	-	-		-	-	-	-	-	1
FI	3	13	0	-	0	-	-	-	-	-		0	0	-	-	16
RU	3	0	0	-	-	-	-	-	-	-	-		-	-	-	3
AT	0	0	-	-	-	-	-	-	-	-	0	-		0	-	0
HU	0	0	-	-	-	-	-	-	-	-	0	-	0		-	0
ES	0	0	-	-	0	-	-	-	-	-	-	-	-	-		0
Total	1236	4140	925	40	1361	321	64	1	267	4	2	19	0	0	0	8380

Courtesy of JPO As of December 31, 2010 (PCT-PPH requests total 2,323 through June 30, 2011)

Patent Prosecution Highway – Prosecution Experience

Period: July – December 2010

	OSF via National PPH Paths										PCT-PPH OSF	
	 JP	 US	 KR	 OFF:JP	 OFF:US	 OFF:KR	 CA	 DE	 AU	 SG	 JP	 US
Grant Rate (%)	73.1 (56.7)	94.6 ^{*1}	86.9 ^{*3*4} (61.1)	100 (23.7)	95.3 (23.7)	-	92 (56.0)	-	100	50	87.4 (56.7)	100 ^{*1}
First Action Allowance Rate (%)	15 (8.9)	27.9 ^{*2}	27.2 ^{*3*5} (8.4)	11.1	0	0	44 (6.0)	29 ^{*7}	20 ^{*8}	50	50.9 (8.9)	76 ^{*2}
Average Pendency from PPH Request to First Office Action {month}	2 (29.0)	6.7	2.0 ^{*3} (15.4)	1.7	1.2	1.1	2 (23.2)	7.3	0.53	-	1.4 (29.0)	3.9
Average Pendency from PPH Request to Final Decision {month}	8.2 (35.1)	10.6	5.0 ^{*3} (22.2)	9.6 (32.0)	11.5 (32.0)	-	6.1 (42.4)	-	0.99	-	3.3 (35.1)	4.7
Average Number of Office Actions	1.21 (1.17)	1.88	-	1.1	1.8	-	0.6 (1.6)	-	-	0.5	0.56 (1.17)	1.17

- Between July and December 2010:
 - 100% of accepted PCT-PPH requests made to the USPTO were granted patents.
 - 76% of the PCT-PPH requests were allowed on first action by the USPTO
 - The average pendency from USPTO receipt of a PCT-PPH request to allowance was 4.7 months with an average of 1.17 Office Actions.

Courtesy of JPO - <http://www.jpo.go.jp/cgi/linke.cgi?url=/ppph-portal/index.htm>

Patent Prosecution Highway – Users

United States to Japan Top Users*

Ranking	Applicant's Name
1	Microsoft Corporation
2	International Business Machines Corporation
3	General Electric Company
4	SanDisk Corporation
5	Apple Incorporated
6	Xerox Corporation
7	Honda Motor Corporation Limited
8	Altera Corporation
9	GE Medical Systems Global Technology LLC
10	Cree Incorporated
10	Applied Materials Incorporated

*As of December 2010

United States to Korea Top Users*

Ranking	Applicant's Name
1	Microsoft Corporation
2	SanDisk Corporation
3	Qualcomm Incorporated
4	Google Inc.
5	Frito-Lay North America, Inc.
6	Apple Inc.
7	Lam Research Corporation
8	Graftech International Holdings Inc.
9	GE Healthcare Ltd.
10	Novinium, Inc.

*As of December 2010

Patent Prosecution Highway – Agenda

- Define The PPH
- Where The PPH Can Be Used
- When And How To Use The PPH
- Experience Statistics
- **Why And Why Not To Use The PPH**
- Example Strategies

Patent Prosecution Highway



Why Use the PPH?

Patent Prosecution Highway – PPH Benefits

- Expedite prosecution of claims toward patentability (≤ 36 Months)
- Decrease prosecution costs by reducing the number of Office Actions (~25+% savings possible)
- Compact prosecution
- Similar file histories in all jurisdictions
- Quicker patentability determinations
- Particularly attractive to rapidly evolving industries
- Obtain one patent quickly and pursue additional coverage via one or more continuing application



Why Not to Use the PPH?

Patent Prosecution Highway – PPH Confounds

- Use of the PPH will likely result in no Patent Term Adjustment benefit, meaning the patent may expire sooner.
- Generally, less searching is performed in jurisdictions where the application is treated under the PPH. Less searching typically results in fewer references being considered.
- Use of the PPH reduces options for handling later identified references that should be considered during prosecution. A later identified reference may require reexamination to have the reference considered.
- With a pending US application not subjected to the PPH in the same family as a patent obtained quickly via PPH may lead to an obvious-type double patenting rejection forcing a terminal disclaimer and thereby defeating an attempt to benefit from Patent Term Adjustment.

Patent Prosecution Highway – Agenda

- Define The PPH
- Where The PPH Can Be Used
- When And How To Use The PPH
- Experience Statistics
- Why And Why Not To Use The PPH
- **Example Strategies**

Patent Prosecution Highway



Strategies for Utilizing the PPH

Patent Prosecution Highway – Filing Strategies

- There are many different ways to leverage the PPH to achieve different goals.
- The next few slides illustrate first a common non-PPH filing strategy followed by a strategy illustration that can be utilized to lower costs and expedite the patenting process in multiple jurisdictions.
- The last slide illustrates a strategy to utilize the PPH for purposes of accelerating examination to obtain a US patent quickly.
- While these PPH strategy illustrations do not guarantee lower costs or expedited patenting, so long as the initially filed PCT claims are drafted with acceleration in mind, cost savings are likely.
- If you still desire broader claim coverage, so long as the specification provides support for broader claims, you can file a continuation or divisional application to the broader claims.

Patent Prosecution Highway – Filing Strategies

EXAMPLE NON-PPH FILING STRATEGY

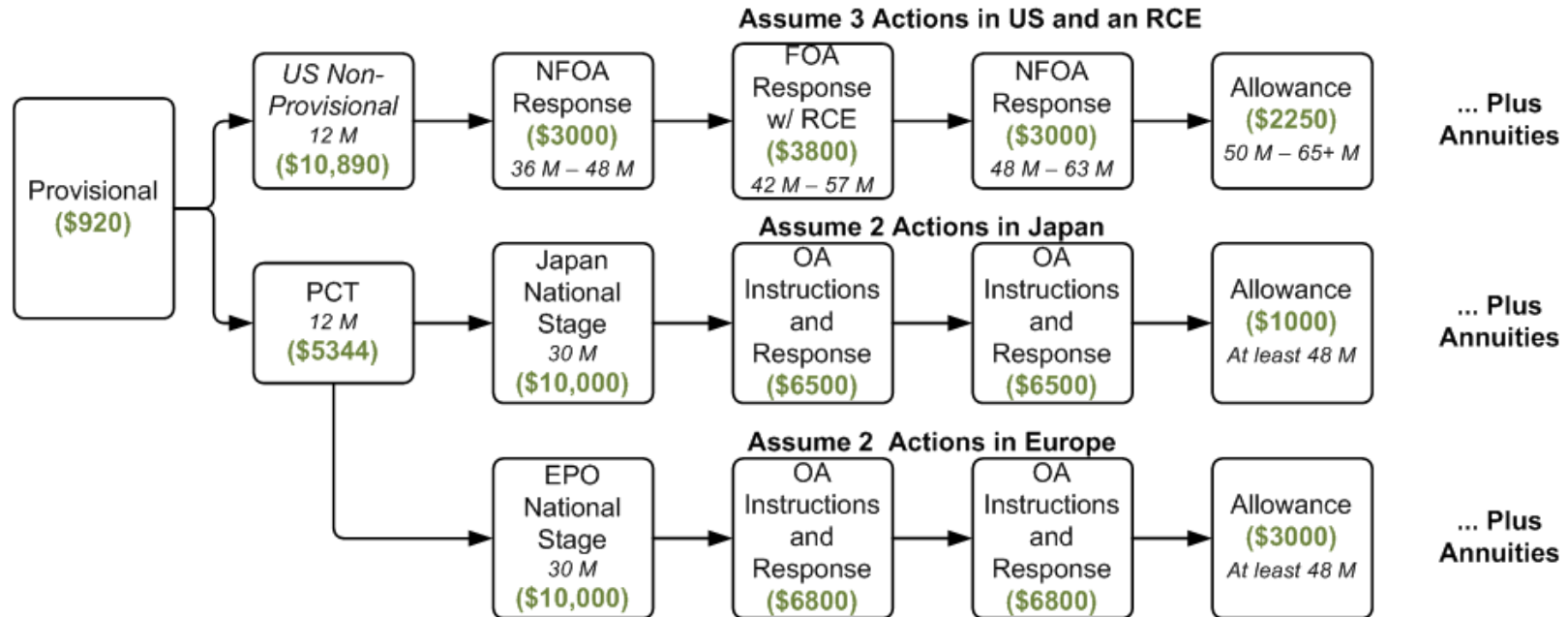

\$79,804 base line of costs with the following illustrations.

None of US, EP, or JP patents likely to issue within 48 months.

Patent Prosecution Highway – Filing Strategies

PPH STRATEGY PROPOSAL – US, JP, EP

PPH Time to National Stage allowance ca. 12+ M ≤ 36 M
 Non-PPH Time to National Stage Allowance in US – add ca. 24 Months?

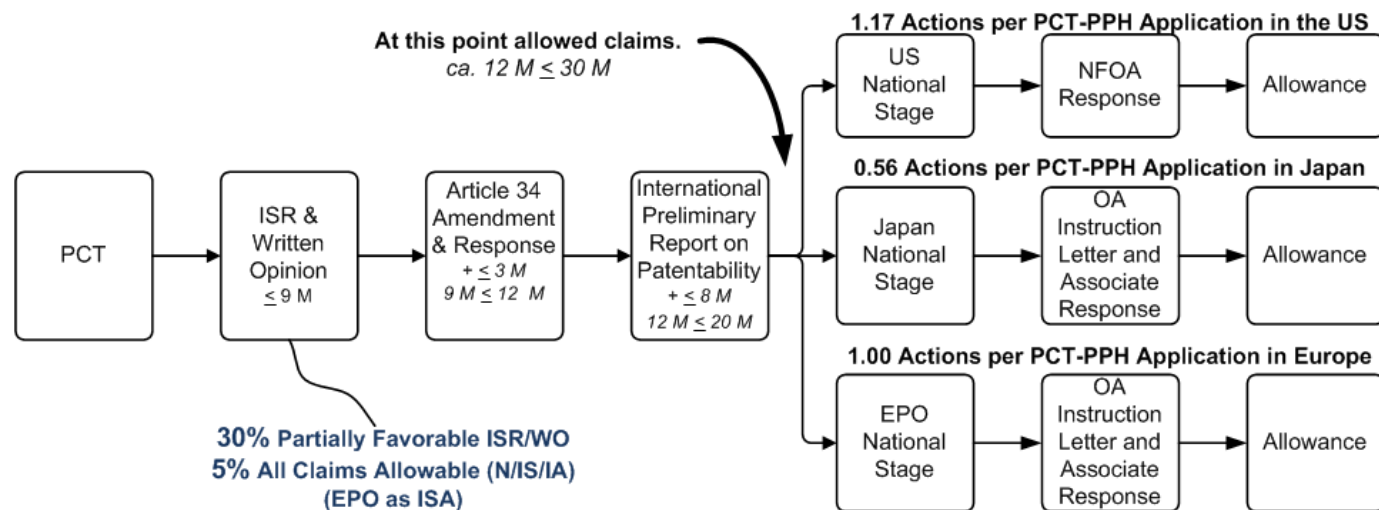

PCT and National Stage Filings	\$36,234
Article 34 Response and Demand (\$3,206 + \$600 Prelim. Exam Fee)	\$ 3,806
US Prosecution averaging 1.17 action responses at \$3000/response	\$ 3,510
US PPH Request	\$ 1,500
JP Prosecution averaging 0.56 action responses at \$2,500 per SLW instruction letter at \$4,000 per JP Associate fee	\$ 3,640
JP PPH Request	\$ 2,000
JP PCT prosecution document translation (high estimate)	\$ 1,000
EP Prosecution averaging 1 action response at \$2,500 per SLW instruction letter at \$4,300 per EP Associate fee	\$ 6,800
Subtract EP National Stage Arguments and Amendments (\$2,500 SLW + \$-6,800 \$4,300 EP Associate Fee saved as not needed since allowed)	
EP PPH Request	\$ 2,000
Allowance/Registration Costs	\$ 6,250
Total	\$59,940

\$19,864 savings (\$23,670 w/ favorable ISR) per PCT family and US, EP, and JP patents likely issued within 36 months.

(Ignoring Annuities and IDS Costs)

Patent Prosecution Highway – Filing Strategies

PPH STRATEGY PROPOSAL – US, JP, EP – No CLAIMS ALLOWED NATIONAL STAGE FILED

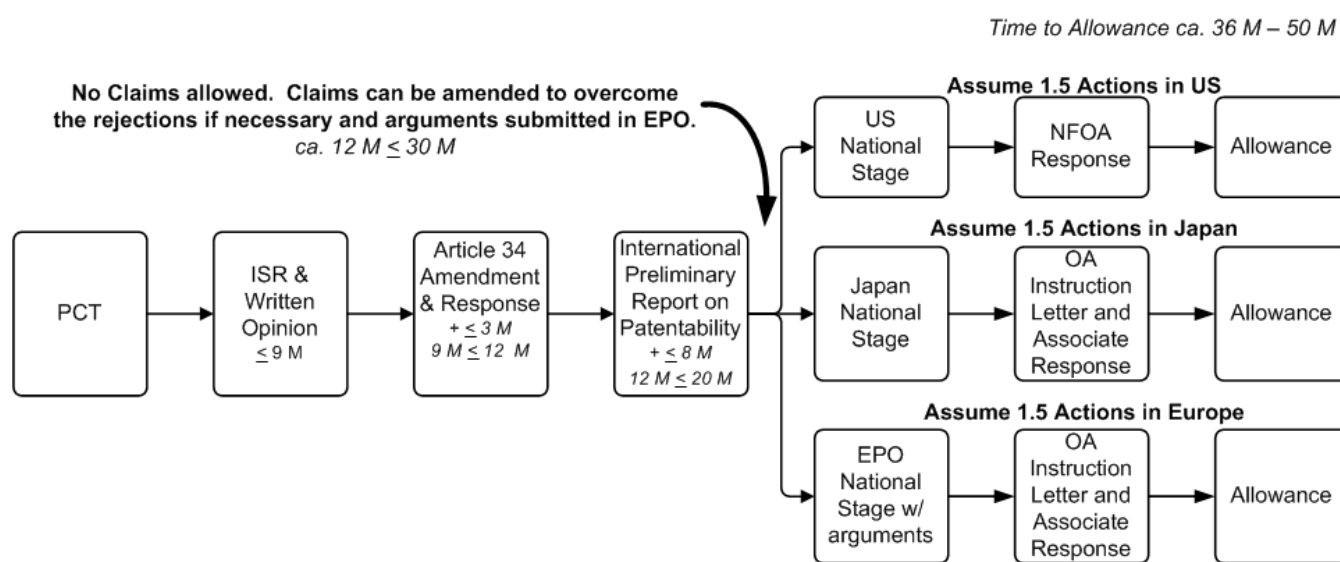

PCT and National Stage Filings	\$36,234
Article 34 Response and Demand (\$3,206 + \$600 Prelim. Exam Fee)	\$ 3,806
US Prosecution averaging 1.5 action responses at \$3,000/response	\$ 4,500
JP Prosecution averaging 1.5 action responses at \$2,500 per SLW instruction letter at \$4,000 per JP Associate fee	\$ 9,750
EP Prosecution averaging 1.5 action responses at \$2,500 per SLW instruction letter at \$4,300 per EP Associate fee	\$10,200
Allowance/Registration Costs	\$ 6,250
Total	\$70,740

\$9,064 savings per PCT family and US, EP, and JP patents likely issued in 36 – 50 months.

Patent Prosecution Highway – Filing Strategies

PPH STRATEGY PROPOSAL – US, JP, EP – No CLAIMS ALLOWED ABANDONED

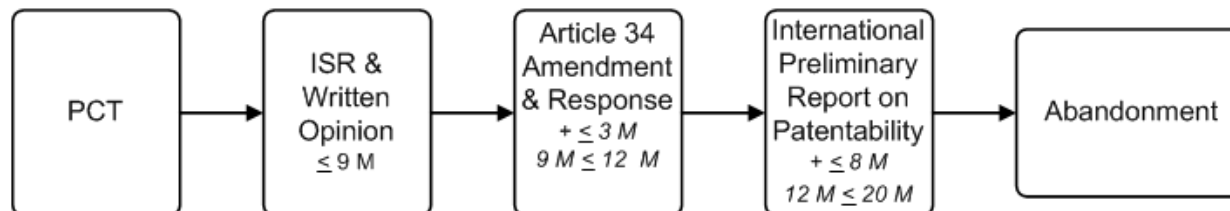

Provisional Only Prep, docketing, filing fees	\$ 700
Provisional Filing Fee	\$ 220
US Prosecution averaging 3 action responses including an RCE at \$3,000 per response and \$800 RCE fee	\$ 9,800
JP Prosecution averaging 2 action responses at \$2,500 per SLW instruction letter at \$4,000 per JP Associate fee	\$13,000
EP Prosecution averaging 2 action responses at \$2,500 per SLW instruction letter at \$4,300 per EP Associate fee	\$13,600
US National Stage (\$1,090 Filing Fee + \$500 SLW)	\$ 1,590
JP National Stage and Translation (\$6,000 JP Associate, Filing Fee, & Translation + \$3,000 Exam Request Fee + \$500 SLW)	\$ 9,500
EP National Stage + Amendments and Arguments (\$6,500 filing fee + \$2,500 SLW + \$4,300 EP Associate)	\$13,300
Allowance/Registration Costs	\$ 6,250
Less PCT Fees (\$3,000 Art. 34 Amendments + \$600 Preliminary Examination Fee + \$206 Handling Fee)	\$-3,806
Total	\$64,134 Savings
(Ignoring Annuities and IDS Costs)	

Patent Prosecution Highway – Filing Strategies

PPH STRATEGY PROPOSAL – COST SAVING PER 100 MATTERS

For 100 cases filed, the following savings can be realized over the illustrated common non-PPH filing strategy:

If:

10% IPRP Allowable Claims	\$ 198,640
80% IPRP No Allowable Claims but file NS	\$ 725,120
<u>10% IPRP No Allowable Claims and Abandon</u>	<u>\$ 641,540</u>
Total	\$1,565,300

20% IPRP Allowable Claims	\$ 397,280
70% IPRP No Allowable Claims but file NS	\$ 634,480
<u>10% IPRP No Allowable Claims and Abandon</u>	<u>\$ 641,540</u>
Total	\$1,673,300

20% IPRP Allowable Claims	\$ 397,280
75% IPRP No Allowable Claims but file NS	\$ 679,800
<u>5% IPRP No Allowable Claims and Abandon</u>	<u>\$ 320,770</u>
Total	\$1,397,850

30% IPRP Allowable Claims	\$ 595,920
60% IPRP No Allowable Claims but file NS	\$ 543,840
<u>10% IPRP No Allowable Claims and Abandon</u>	<u>\$ 641,540</u>
Total	\$1,781,300

Patent Prosecution Highway – Filing Strategies

PPH STRATEGY PROPOSAL – US ONLY

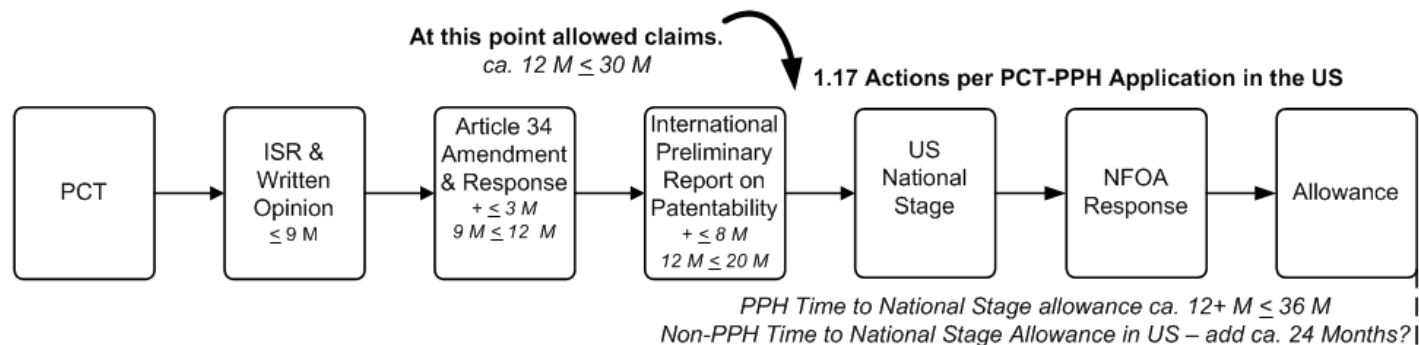

PCT Filing Fees (Transmittal, Search, Int'l Filing Fees at least)	\$ 3,461
Article 34 Response and Demand (\$3,000 + \$600 Preliminary Exam fee + \$206 Handling Fee)	\$ 3,806
US Prosecution averaging 1.17 action responses including an RCE at \$3,000 per response	\$ 3,510
US PPH Request	\$ 1,500
Total	\$12,277

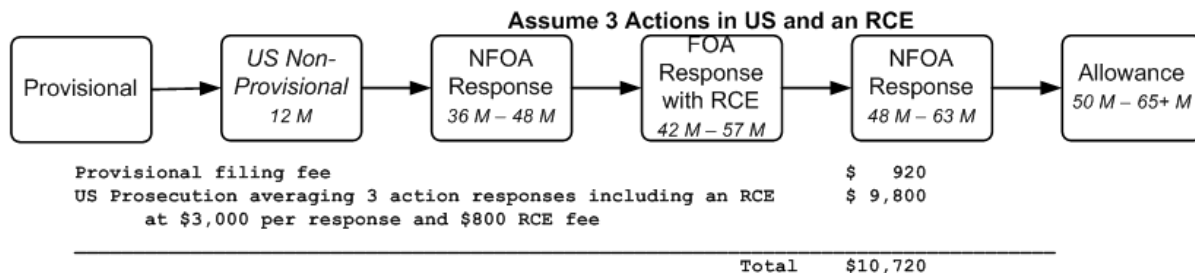

If PCT-PPH is utilized, but nationalized only in the US, there is at least a \$1,557 premium. But the case is allowed within 36 M if the IPRP is favorable and likely within 48 months if IPRP is unfavorable. Also, filing PCT preserves the option to nationalize in other countries.

Patent Prosecution Highway – Overall Considerations

Significant Overall Cost Difference

- For US, EP, JP strategy:
 - ~25% Reduction in overall family cost
(assuming ~\$20K saved per Family, likely even more)
 - If Favorable ISR/WO, then no Ch. II (Art. 34 + Demand)
(Additional \$3,806 Saved per Family)
- IDS Costs and Associated Risks are also Avoided
- Compact Prosecution
- Similar File History in All Jurisdictions

Patent Prosecution Highway – Overall Considerations

Attorney drafting time represents less than 10% of the total family cost, assuming ~\$7.5K of initial drafting.

- \$2k savings per case would be less than 3% of the total

But, the quality of the attorney's search and claims will dominate the course of prosecution

- Favorable ISR/WO at CH. 1?
- Art. 34 + demand for allowable claims at CH. 2?
- Abandon?
- Questionable validity?
- Drafter aware of international drafting considerations for EPO, JP, AU, CN?

Patent Prosecution Highway – Overall Considerations

What Role does Drafting Play?

- Validity will strongly depend on search quality and the resulting claims drafted in view of the search
- Under the PPH, you likely only get a single search by an examiner, such as by the international search authority (ISA) for a PCT matter
- Drafting errors undermine savings, resulting in higher abandonment rates and no advancement of prosecution in the international phase
 - Such Errors also Lead to Potential Invalidity
- If the drafter fails to understand the state of the art, or fails to draft in view of international considerations, the ISA may not save them

Patent Prosecution Highway – Summary

- While conceptually PPH is easy to appreciate, developing a strategy to leverage the PPH can be complex and does not involve simply choosing a PPH menu option if it is to be used strategically to obtain optimal results for your organization.
- However, the various forms of PPH provide interesting options for obtaining patents quickly with opportunities for significant cost savings.
- At the same time, application workup through prior art searching and quality claim and specification drafting are key to fully realizing the benefits of the PPH.



SCHWEGMAN ■ LUNDBERG ■ WOESSNER
Intellectual Property Attorneys

PATENT PROTECTION FOR HIGH TECHNOLOGY

Thank you for your participation.

For more information please visit :
www.SLWip.com



Suneel Arora
612 373 6951
sarora@slwip.com



James D. Hallenbeck
612 373 6938
jhallenbeck@slwip.com

MINNESOTA

1600 TCF Tower
121 South 8th Street
Minneapolis, MN 55402
612.373.6900

CALIFORNIA

150 Almaden Boulevard
Suite 750
San Jose, CA 95113
408.278.4040

TEXAS

8911 Capital of Texas Highway
Suite 4150
Austin, TX 78759
512.628.9320